

# Space Saver

Installation, commissioning  
and user manual

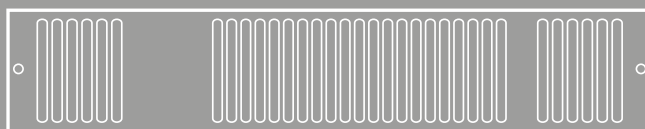

SS3 | SS5 | SS7 | SS9

# Contents

Introduction	2
Declaration of conformity	3
Symbols used in this guide	3
Important safety and installation instructions	4
Application	6
Product Information	6
Installation	8
Electrical connections	9
Commissioning	9
Fault finding	10
User Manual	
Important safety guidance	12
Introduction	13
Operation	13
Fault finding	14
Registering your product	15
Disposal	15
After sales and spares	15

# Introduction

The following items are included in the carton:

- Product complete with Stainless steel grille and pre-wired mains cable.
- Fixing screws (2).
- One pair flexible installation hoses (not included with SS3 model).

Accessory grilles which fit in place of standard grille are available in different colours and finishes. Please consult the price list for details. In the event of any items missing or visible damage, please contact us on +44 (0) 1245 324560.

Please leave this Installation and User Guide with the owner of the property.

# Declaration of conformity

EC Declaration of conformity

We, Smith's Environmental Products Limited  
1-2 Blackall Industrial Estate  
South Woodham Ferrers  
Chelmsford  
Essex CM3 5UW  
Tel: 01245 324900 Fax: 01245 324422

Declare under sole responsibility that the products:

Product name:  
**Space Saver**

Product range:  
**SS3/MK5, SS5/MK5, SS7/MK5, SS9/MK5, SS5D/  
MK5, SS512V, SS2E/MK5**

Listed above conforms with the following  
European Union directives:

**Low Voltage Directive (73/23/EEC)**  
**EMC Directive (89/336/EEC)**  
**Pressure Equipment Directive (97/23/EC)**  
**Machinery (98/37/EC)**

Standards comply with the above directives.

Safety Directive Standards:  
**EN 60335-2-80:2003 + A1:04 in conjunction  
with EN 60335-1:2002 + A11:04 + A1:04 +  
A12:06 + A2:06**  
**With UK deviations**

This Declaration is made on behalf of Smith's  
Environmental Products Limited

# Symbols

This manual contains information and  
prescriptions marked by the following symbols.



Ignoring these safety provisions  
marked by the symbol "caution:  
hazard" may endanger the safety of  
people.



Ignoring these safety provisions  
marked by the symbol "caution:  
electricity" may endanger the  
safety of people, as well as the  
integrity of things.



The removal of the screws can  
cause the output of hot fluids  
under high pressure from heating  
system. Drain the system or close  
the isolating valves.



High temperature surface. Take  
utmost care to prevent people  
from getting in contact with the  
hot surfaces of the appliance.

---

# Important safety and installation instructions

Prior to installation, read these installation and operating instructions. The installation and operation should also be in accordance with national regulations and accepted codes of good practice.



This appliance is not intended for use by persons (including children) with reduced physical, sensory or mental capabilities, or lack of experience and knowledge, unless they have been given supervision or instruction concerning use of the appliance by a person responsible for their safety. Children should be supervised to ensure that they do not play with the appliance.

To guard against injury, basic safety precautions should be observed, including the following:

1. Read and follow all safety instructions and all the important notices on the appliance before installing, using and maintaining the appliance. Failure to do so may cause personal injury or damage to the appliance or installation.
2. Always disconnect electrical supply before putting on or taking off parts and whilst the equipment is being installed, maintained or handled. Never work with bare feet and/or with wet hands.
3. To avoid possible electric shock, special care should be taken since water is used with electrical equipment. Carefully examine the appliance before and after installation. Do not operate the appliance if it has a damaged supply cord or enclosure, or if it is malfunctioning or it is dropped or damaged in any manner. Inspect the appliance periodically.



The appliance should not be electrically supplied if there is water on parts not intended to be wet.

4. Risk of scalding. To avoid injury before any servicing operation wait until the water has cooled inside the appliance. Do not touch the fluid or the appliance when temperature is higher than 60°C.



5. Improper use.

This is an appliance to be used in heating systems with clean water without abrasive particles.



Do not use this appliance:

- With liquids other than water (e.g. flammable liquids, etc.) (EN60335-2-51);
- In locations where special conditions prevail, such as the presence of a corrosive or explosive atmosphere (dust, vapour or gas) (EN60335-2-51);
- For other than intended use.

6. Installation.

The appliance must be mounted in a stable/fixed position in a dry, well ventilated, frost-free, waterproof and protected place, with sufficient ventilation around it. Make sure that the appliance is securely and correctly installed before operating it and that there is enough room around it for maintenance operations, dismantling, checking for free inspection.

The maximum ambient temperature at which the appliance is to be used is 40°C (EN60335-2-51).



7. Electric connection

**IMPORTANT:** Connection to the power supply is by means of an IEC power cable which can be fitted with a plug-type connection or a two pole isolating switch with a minimum contact opening of 3 mm.

Electrical connection must be carried out by a qualified electrician and in accordance with local regulations and both data on the name-plate and the appropriate diagram inside the terminal box cover.

Follow all safety standards.

8. Connect the appliance only to a mains supply protected by a Residual Current Device (RCD or Ground-Fault Circuit-Interrupter) with a rated residual operating current not exceeding 30mA.
9. Prior to any modification being made to the equipment, it must be agreed with and authorised by the manufacturer. Original spare parts and accessories authorised by the manufacturer are integral part contributing to the safety of the equipment and of the machines. The use of non original components or accessories may endanger the safety and causes the termination of the warranty. Safe operation is only assured for the applications and conditions described in Application of this manual.

Non-observance of the safety instructions results in the loss of any claims to damages.

The indicated limit values are binding and cannot be exceeded for any reason whatsoever.

KEEP THESE INSTRUCTIONS FOR FUTURE REFERENCE.

# Application

Space Saver is primarily intended for installation in the space beneath kitchen cupboards behind the plinth. However, it can be also installed in similar applications such as stair cases and other built-in furniture.

This Space Saver model must NOT be installed in a bathroom or other areas of high humidity. Please contact us on +44 (0) 1245 324560 for details of products suitable for these applications.

Space Saver is designed for use on standard two-pipe pumped central heating systems. Pipes are 15mm and either may be used as flow or return. This product is not suitable for one-pipe system.

To conform with Building Regulations Part L (Part J in Scotland), a remote room thermostat (Smith's Part No. 08-0826) can be used in conjunction with this Space Saver fan convector.

Please note the guarantee may be invalidated if this product is not installed and used in accordance with this guide.

# Product performance

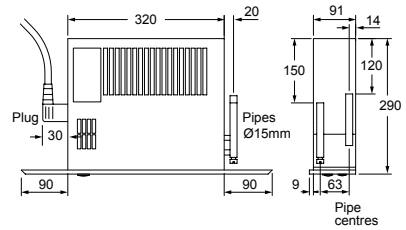

SS3/SS5

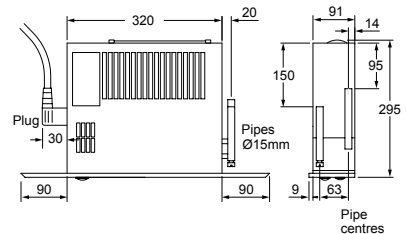

SS7

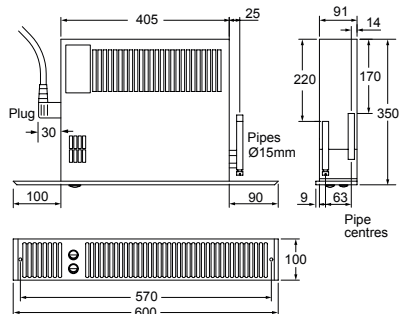

SS9

## Heat output

It is recommended that the Space Saver model chosen is capable of maintaining the calculated heat loss at normal heat output (I) enabling the boost setting (II) to be used for faster heat up.

Model	Room size guide* (m <sup>3</sup> )	Heat Output at 80°		Heat Output at 75°		Heat Output at 70°		Heat Output at 65°	
		Normal (kW)	Boost (kW)	Normal (kW)	Boost (kW)	Normal (kW)	Boost (kW)	Normal (kW)	Boost (kW)
<b>Hydronic</b>									
SS3 (Improved heat output)	31	1.1	1.4	1.0	1.3	0.9	1.2	0.8	1.1
SS5	37	1.3	1.7	1.2	1.6	1.1	1.4	1.0	1.3
SS7	46	1.6	1.9	1.4	1.8	1.3	1.6	1.2	1.5
SS9	63	2.2	2.4	2.1	2.2	1.8	2.0	1.7	1.8

Model	Room size guide* (m <sup>3</sup> )	Heat Output at 60°		Heat Output at 55°		Heat Output at 50°		Heat Output at 45°	
		Normal (kW)	Boost (kW)	Normal (kW)	Boost (kW)	Normal (kW)	Boost (kW)	Normal (kW)	Boost (kW)
<b>Hydronic</b>									
SS3 (Improved heat output)	31	0.7	1.0	0.6	0.9	0.5	0.8	0.4	0.7
SS5	37	0.9	1.1	0.8	1.0	0.7	0.9	0.6	0.8
SS7	46	1.1	1.3	1.0	1.2	0.9	1.0	0.8	0.9
SS9	63	1.5	1.7	1.3	1.5	1.1	1.3	0.9	1.1

\*Room sizes given in cubic metres for general guidance only based on normal heat output (80°C) for domestic applications - always calculate heat losses. Heat outputs tested in accordance with BS4856 using entering water temperature and 340 l/h (75gph) flow rate. Fan-only option operational only when central heating system is switched off. Dual models include an electric element which in electric heating mode will emit 1kW of heat.

# Installation

## 1. Cut the opening in the plinth

- To ensure adequate airflow, a minimum clearance of 20mm between the top of the product and any shelving is essential.
- To avoid the possibility of vibration, this product must be installed on a flat, even surface.
- There must be no rear access to the product after completion of the installation.

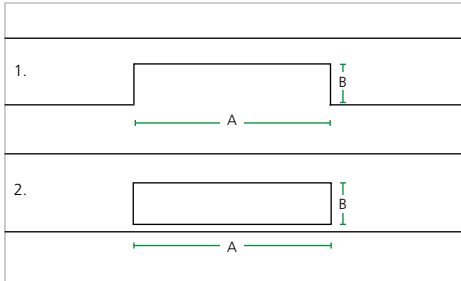

- We recommend the use of a knee pad when installing this product.
- Cut the opening in the plinth to the size shown in the table. Use method 1 or 2.

Model	Width A (mm)	Height B* (mm)
SS3	465	96
SS5	465	96
SS7	465	96
SS9	560	96

\* The overall height of the grille is 100mm. Use care when cutting the opening.

## 2. Fit isolating valves (not supplied)

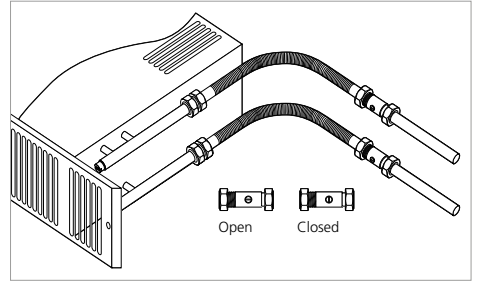

- Fit isolating valves (not supplied) to the system flow and return pipes. In order to achieve the highest level of performance we recommend full bore valves.
  - Failure to fit isolating valves may mean that the product is not serviceable in the event of failure.
  - Connect the flexible hoses between system pipework and heater. Please ensure the flexible hoses are not kinked.
  - Open the isolating valves and check for leaks.
- N.B. either pipe may be used on flow or return.

The Flexible installation hoses supplied are suitable for use with either 15mm diameter copper pipe or 15mm cross-linked polythene barrier pipe to BS 7291. The only type of fitting approved to connect onto the heater are compression fittings.

## 3. Vent air through bleed

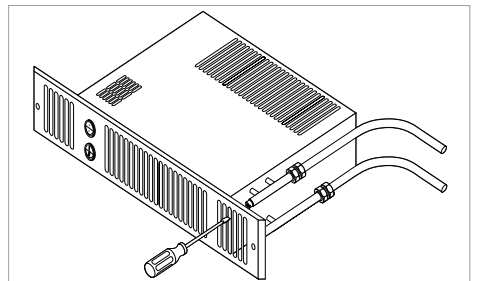

## 4. Connection to power supply

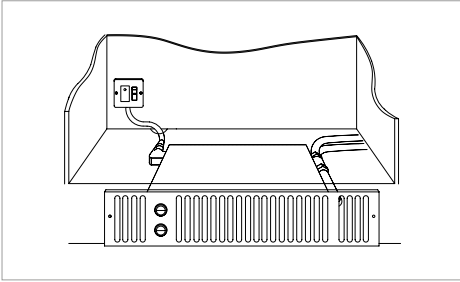

- Isolate electrical supply and connect the heater's electric cable to the fused spur (3A).
- Ensure the fused spur is not directly above the heater and is accessible after installation is complete.

Space Saver is classified as a fixed appliance and electrical connection should be via a double pole 3A fused spur with a minimum contact gap of 3mm. If the pre-wired mains cable is damaged, it must be replaced by either the manufacturer, its service agent or similarly qualified persons. The appliance must be earthed.

## 5. Position heater

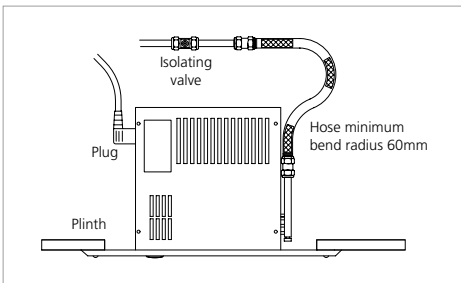

Position the heater, making sure the flexible hoses are not kinked and the electrical cable is not snagged.

## 6. Fix to plinth

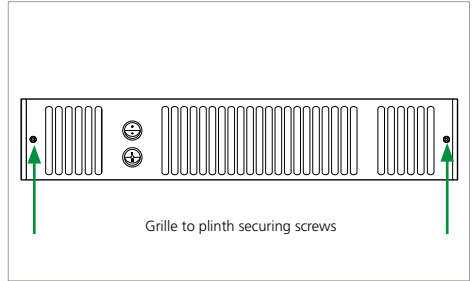

Fix the heater to the plinth using the screws provided and by means of the holes positioned to left and right hand sides.

## Commissioning

1. Turn on the electrical supply at the fused spur.
2. Set the upper control switch on the fascia grille to BLUE and the lower switch to either I or II. The fan will run.

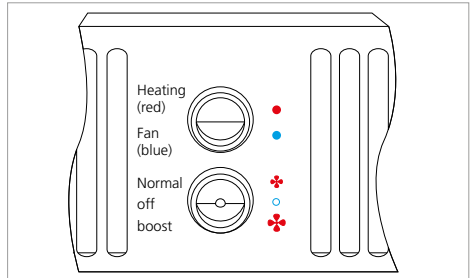

3. Set the lower heat output switch to I and the upper switch to RED (the unit is now in heating mode)
4. Turn on the central heating system and set any room thermostat/s to maximum.
5. Within a few minutes (10-15 mins) the fan should run and heat will flow.
6. Balance the central heating system if Space Saver is installed on the same circuit as panel radiators.
7. When the installation is working correctly, remember to reset any room thermostat(s) to its normal setting.

# Fault finding

In the event of any difficulty, please contact us on +44 (0) 1245 324560.

It will be more helpful if you do not remove the product from the central heating system.

Fault	Checking/Solution
Fan does not run on any switch setting	Check the power supply is switched ON Check fuse in fused spur Check the wiring connections at the fused spur
No heat output on settings I and II	Check the power supply is switched ON If possible, check that both the copper pipes on the side of the unit are hot Ensure that the flexible connections are not kinked If fitted, ensure any room thermostats are calling for heat Balance the central heating system if installed on same circuit as panel radiators and increase the circulating pump speed if required Increase the boiler water temperature Check the service valves are open Bleed air from appliance

# Space Saver

User manual

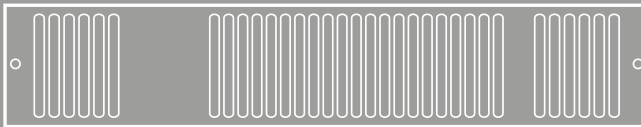

SS3 | SS5 | SS7 | SS9

# Important safety and installation instructions

Please read this user manual before operating this appliance. The operation should also be in accordance with national regulations and accepted codes of good practice.



This appliance is not intended for use by persons (including children) with reduced physical, sensory or mental capabilities, or lack of experience and knowledge, unless they have been given supervision or instruction concerning use of the appliance by a person responsible for their safety. Children should be supervised to ensure that they do not play with the appliance.

To guard against injury, basic safety precautions should be observed, including the following:

1. Read and follow all safety instructions and all the important notices on the appliance before installing, using and maintaining the appliance. Failure to do so may cause personal injury or damage to the appliance or installation.
2. Always disconnect electrical supply before putting on or taking off parts and whilst the equipment is being installed, maintained or handled. Never work with bare feet and/or with wet hands.
3. To avoid possible electric shock, special care should be taken since water is used with electrical equipment. Carefully examine the appliance before and after installation. Do not operate the appliance if it has a damaged supply cord or enclosure, or if it is malfunctioning or it is dropped or damaged in any manner. Inspect the appliance periodically.



The appliance should not be electrically supplied if there is water on parts not intended to be wet.



4. Risk of scalding. To avoid injury before any servicing operation wait until the water has cooled inside the appliance. Do not touch the fluid or the appliance when temperature is higher than 60°C.

5. Improper use.

This is an appliance to be used in heating systems with clean water without abrasive particles.



Do not use this appliance:

- With liquids other than water (e.g. flammable liquids, etc.) (EN60335-2-51);
- In locations where special conditions prevail, such as the presence of a corrosive or explosive atmosphere (dust, vapour or gas) (EN60335-2-51);
- For other than intended use.

Non-observance of the safety instructions results in the loss of any claims to damages.

The indicated limit values are binding and cannot be exceeded for any reason whatsoever.

KEEP THESE INSTRUCTIONS FOR FUTURE REFERENCE.

## How it works

Hot water from your central heating system passes through a heat exchanger transferring its heat to the aluminium fins. Cooler air is drawn in by the fan and heated as it passes through the heat exchanger before being discharged gently back into the room. This not only gives a more even temperature spread, but will heat up a room quicker than a traditional panel radiator.

Space Saver includes an internal thermostat that prevents the fan from operating until the central heating system water passing through the heat exchanger reaches 33°C. This prevents the Space Saver circulating cooler air at start up.

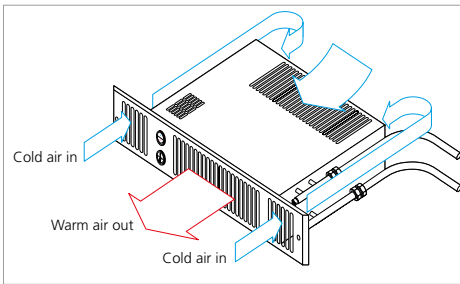

## How to operate

Your Space Saver fan convector is designed to operate as part of your central heating system in the same way as a panel radiator. Providing the lower heat output switch is left in either the normal (I) or boost position (II) and the upper switch is in the HEATING position your Space Saver will switch on and off automatically with your central heating system.

Ensure your central heating system is on, the lower switch set to normal and the upper switch to heating RED. Providing the water temperature in the system is more than 33°C and the thermostat controlling your central heating system is calling for heat, your Space Saver will switch on.

If you require a faster warm up, move the lower switch to boost (II). Moving the switch to (O) will turn off the Space Saver.

Fan convectors are usually only used on the lower setting and this is our recommendation. In those rare cold spells the boost may be required for a short period to bring a room up to temperature.

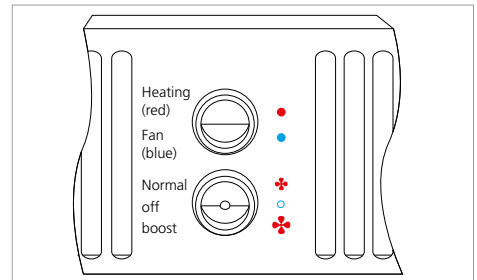

### Air Circulation (Summer use)

Ensure your central heating system is off. Set the upper switch to BLUE and the lower switch to (I) or (II). Space Saver will run to provide a flow of air. If used in conjunction with a remote room thermostat, ensure the thermostat is set to maximum.

# Fault finding

This Space Saver is covered by a free 5-year parts and labour guarantee.  
Please refer to the Fault finding table below for advice.  
In the event of difficulty, please contact us on +44 (0) 1245 324560.

It will be helpful if you do not disconnect the Space Saver from your central heating system.

Fault	Checking/Solution
Fan does not run on any switch setting	Check the power supply is switched ON Check fuse in fused spur Check the wiring connections at the fused spur
No heat output on settings I and II	Check the power supply is switched ON If possible, check that both the copper pipes on the side of the unit are hot Ensure that the flexible connections are not kinked If fitted, ensure any room thermostats are calling for heat Balance the central heating system if installed on same circuit as panel radiators and increase the circulating pump speed if required Increase the boiler water temperature Check the service valves are open Bleed air from appliance

# Registering your product

Thank you for purchasing a Smith's product. It has been designed and manufactured to the highest quality standards to ensure it gives you efficient and trouble-free service for many years. To back up our commitment, included with your product is the following warranty:

## 5 years from date of purchase

This gives you the peace of mind that in the unlikely event of product failure, we will repair or replace the product completely free of charge providing the product has been installed, used and maintained in accordance with the instructions. Your statutory rights are not affected by this warranty.

It is important to register as soon as possible online at: [smithsep.co.uk/product-registration/](http://smithsep.co.uk/product-registration/). This will ensure you will receive prompt and efficient service if your product requires attention within the warranty period. If you do not register your product, you will be required to produce proof of purchase prior to receiving service.

For more details please visit our website: [SmithsEP.co.uk](http://SmithsEP.co.uk)

SCAN HERE TO REGISTER  
YOUR PRODUCT

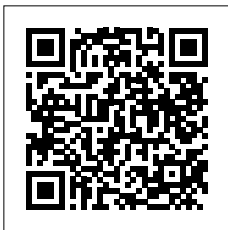

# Disposal

As part of the policy of continuous product improvement, Smith's Environmental Products LTD reserves the right to alter specification without prior notice.

Products with this symbol (crossed out wheellie bin) cannot be disposed as household waste. Old electrical and electronic equipment must be recycled at a facility capable of handling these products and their waste by-products. If you are purchasing replacement equipment your retailer may offer a 'take back' scheme, or will be able to give details of the nearest approved authorised treatment facility. Proper recycling and waste disposal will help conserve resources whilst preventing detrimental effects on our health and the environment.

WEEE Registered Code: WEE/ED0093VW



Approved QCS ISO  
9001:2015



ISO 14001

# After sales and spares

If you experience any problems with the use of your product, please contact our after-sales office +44 (0) 1245 324560.

For product information, customer services or sales support call us on +44 (0) 1245 324900

For the Republic of Ireland, contact MT Agencies on 01 864 3363

Sales: [sales@SmithsEP.co.uk](mailto:sales@SmithsEP.co.uk)

General information: [info@SmithsEP.co.uk](mailto:info@SmithsEP.co.uk)

Smith's Environmental Products Ltd  
Blackall Industrial Estate, South Woodham Ferrers,  
Chelmsford, Essex CM3 5UW

[SmithsEP.co.uk](http://SmithsEP.co.uk)

[@SmithsEP\\_UK](https://twitter.com/SmithsEP_UK)

[#ThinkSmiths](https://www.facebook.com/ThinkSmiths)



### **Happy to help**

Smith's Environmental Products Ltd is one of the leading manufacturers of heating and cooling products in the UK. We are committed to achieving the highest standards and our faith is supported by a free five year parts and labour guarantee with every product. Our customer service is second to none and we are happy to offer any help and guidance that you might need.

### **Stockists**

All products are available nationally from Builders' Merchants, Plumbers' Merchants, Heating Equipment Distributors and Kitchen Equipment Distributors. In the event of difficulty, please contact us or visit our website [SmithsEP.co.uk](http://SmithsEP.co.uk) for details of your nearest stockist.

### **Information and advice**

Full technical specifications and list prices is available to download from our website or in hard copy from our office. Also available on our website are price lists, individual product data sheets, installation & user guides, where to buy, who to contact and a media centre.

Alternatively contact our office 9.00am to 5.00pm Monday to Friday.

As part our commitment to continuous improvement Smith's Environmental Products may change the specifications of its products without prior notification or public announcement. All descriptions, illustrations, drawings and specifications in this publication present only general particulars and shall not form part of any contract. All dimensions are in mm unless otherwise stated.

**To view the full product information download the datasheet at:**  
**[www.SmithsEP.co.uk](http://www.SmithsEP.co.uk)**

For product information, customer services or sales support call us on **+44 (0) 1245 324900**

For the Republic of Ireland, contact MT Agencies on 01 864 3363

**Sales:** [sales@SmithsEP.co.uk](mailto:sales@SmithsEP.co.uk)  
**General information:** [info@SmithsEP.co.uk](mailto:info@SmithsEP.co.uk)

Smith's Environmental Products Ltd  
Blackall Industrial Estate, South Woodham Ferrers,  
Chelmsford, Essex CM3 5UW

**[SmithsEP.co.uk](http://SmithsEP.co.uk)**

**[@SmithsEP\\_UK](https://twitter.com/SmithsEP_UK)**

**[#ThinkSmiths](https://www.facebook.com/ThinkSmiths)**

Issue 003 | 85-0023 | May 2025